

INTERCOOLER PIPING KIT

INSTALLATION MANUAL



Installation must be done by a professional.

Read this manual prior to the installation.

Always have access to this manual as well as a factory service manual.

NAME OF PRODUCT	INTERCOOLER PIPING KIT
PART NUMBER	13002-AH001
APPLICATION	HONDA CIVIC TYPE-R(DBA-FK8)
ENGINE	K20C
YEAR 式	2017/9~
REMARKS	<ul style="list-style-type: none">• Estimated time required for installation: One hour

REVISION OF MANUAL

Rev. Number	Date	Manual Number	Details
3-3.01	2018/06	E04253-H22010-00	1 st Edition

Published in June, 2018 by HKS Co., Ltd. (Unauthorized reproduction is strictly prohibited.)

Kit Parts Layout



INDEX

NOTICE/ATTENTION	10
PARTS LIST	11
1. REMOVAL OF FACTORY PARTS	11
2. INSTALLATION OF INTERCOOLER PIPING	13
3. REINSTALLATION OF FACTORY PARTS	15

NOTICE



This manual assumes that you have and know how to use the tools and equipment necessary to safely perform service operations on your vehicle. This manual assumes that you are familiar with typical automotive systems and basic service and repair procedures. Do not attempt to carry out the operations shown in this manual unless these assumptions are correct. Always have access to a factory repair manual. To avoid injury, follow the safety precautions contained in the factory repair manual.

ATTENTION

- This manual indicates items you need to pay attention to in order to install this product safely and lists precautions to avoid any possible damage and/or accidents.
- This product is an automobile part. Do not use for any other purposes.
- HKS will not be responsible for any damage caused by incorrect installation and/or use, or use after modification and/or dismantling of this product.
- This product was designed based on installation onto a specific factory vehicle.
- The specifications of this product are subject to change without notice.
- The instructions are subject to change without notice. Make sure to refer to the most recent instructions.

SAFETY PRECAUTIONS

The following precautions for use of this product are to prevent possible accidents and/or injuries and for proper use.

 WARNING	Indicates risk of serious injury and/or possible death.
 CAUTION	Indicates risk of damage to people or large-scale damage to property. (Large-scale damage is the damage caused by a product defect. Ex. Damage to a vehicle, burnout, etc.)

PARTS LIST

No.	Description	QT	Remarks
1	Intercooler Inlet Pipe	1	
2	Intercooler Outlet Pipe	1	
3	Silicone Hose φ55-60	2	
4	Silicone Hose φ60	2	
5	Hose Band #36	2	
6	Hose Band #40	6	
7	Installation Manual	1	
8	Instruction Manual	1	

1. REMOVAL OF FACTORY PARTS

Before beginning installation, prepare engine oil and disconnect the negative cable from the battery. Use this instruction manual and the manufacturer's service manual as a reference.

- (1) Disconnect the negative cable from the battery.
- (2) Remove ①engine under cover plate and ②engine under cover.
※① and ② will be reused later.

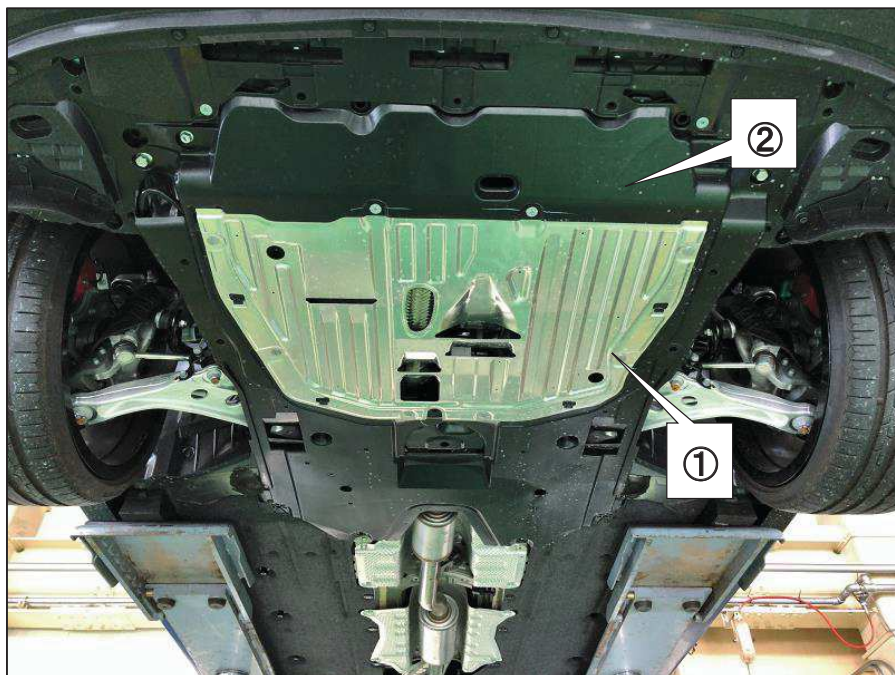

- (3) Remove ③air hose and ④air cleaner box.
※③ and ④ will be reused later.

NOTE

- When removing the clip of the air cleaner box, pull the clip while swaying it to the directions indicated in the diagram below.

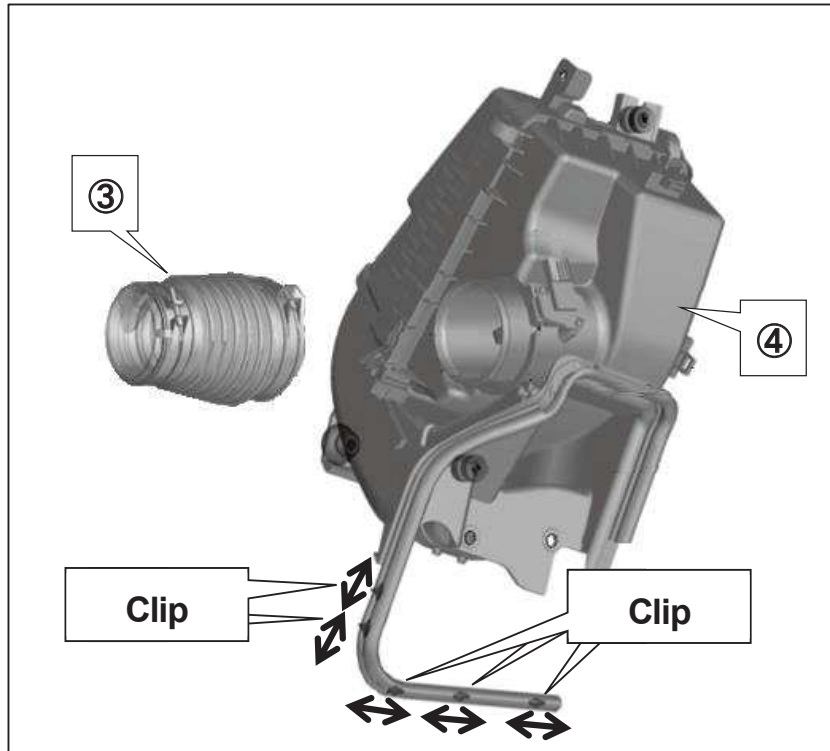

- (4) Remove ⑤intercooler inlet hose and ⑥intercooler outlet hose.

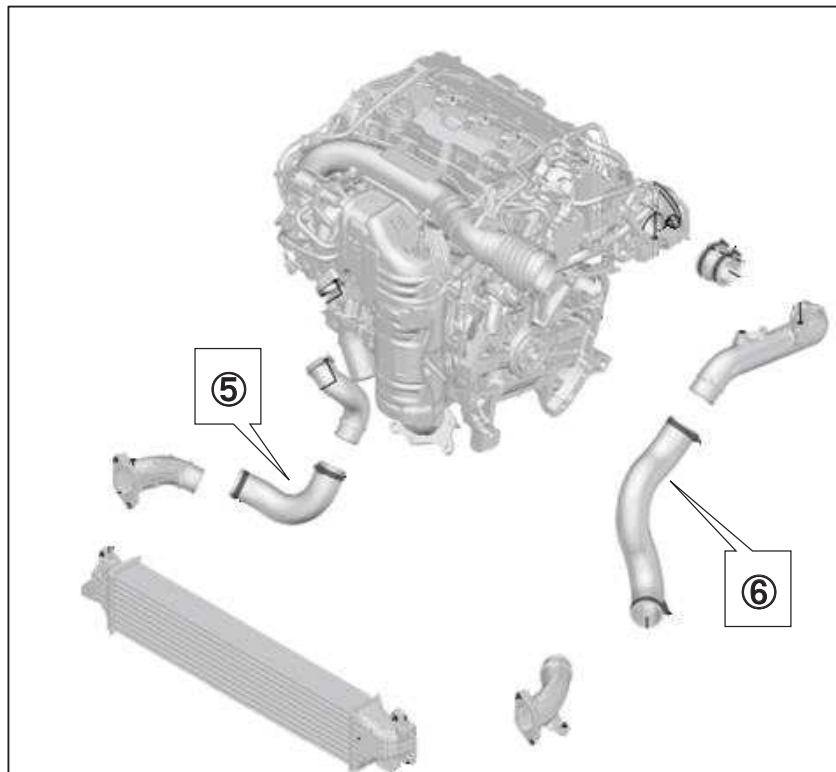

2. INSTALLATION OF INTERCOOLER PIPE

PARTS LIST			
	No.	Description	Qt
	P1	Intercooler Inlet Pipe	1
	P2	Intercooler Outlet Pipe	1
	P3	Silicone Hose φ55-60	2
	P4	Silicone Hose φ60	2
	P5	Hose Band #36	2
	P6	Hose Band #40	6

- (1) Make sure there is no foreign object is inside the kit parts.
- (2) Temporarily install the Silicone Hose φ55-60 to the turbocharger compressor outlet.
 - P3: Silicone Hose φ55-60 × 1
 - P5: Hose Band #36 × 1

NOTE

- Do not completely install the silicone hose; just temporarily install it at this point as shown in the diagram below.
- Install the φ55 side of the silicone hose to the turbocharger side.



(3) Install the Intercooler Inlet Pipe to the turbocharger and intercooler.

- P1: Intercooler Inlet Pipe × 1
- P3: Silicone Hose φ55-60 × 1
- P5: Hose Band #36 × 1
- P6: Hose Band #40 × 2

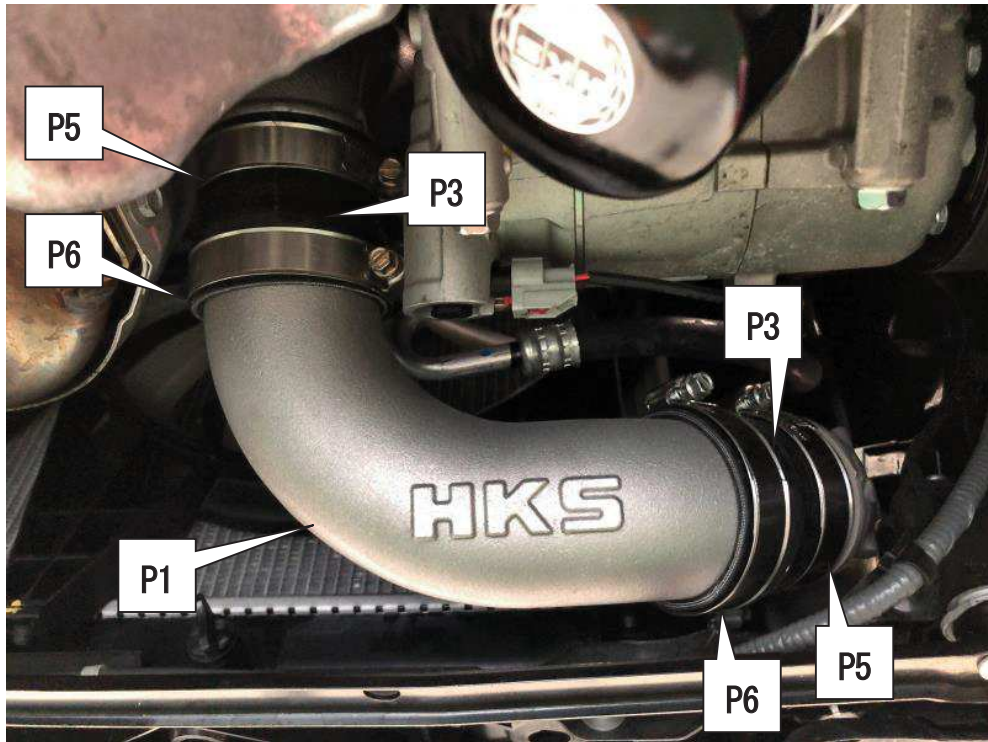

(4) Install the Intercooler Outlet Pipe to the intercooler and pipe before the throttle.

- P2: Intercooler Outlet Pipe x 1
- P4: Silicone Hose φ60 × 2
- P6: Hose Band #40 × 4

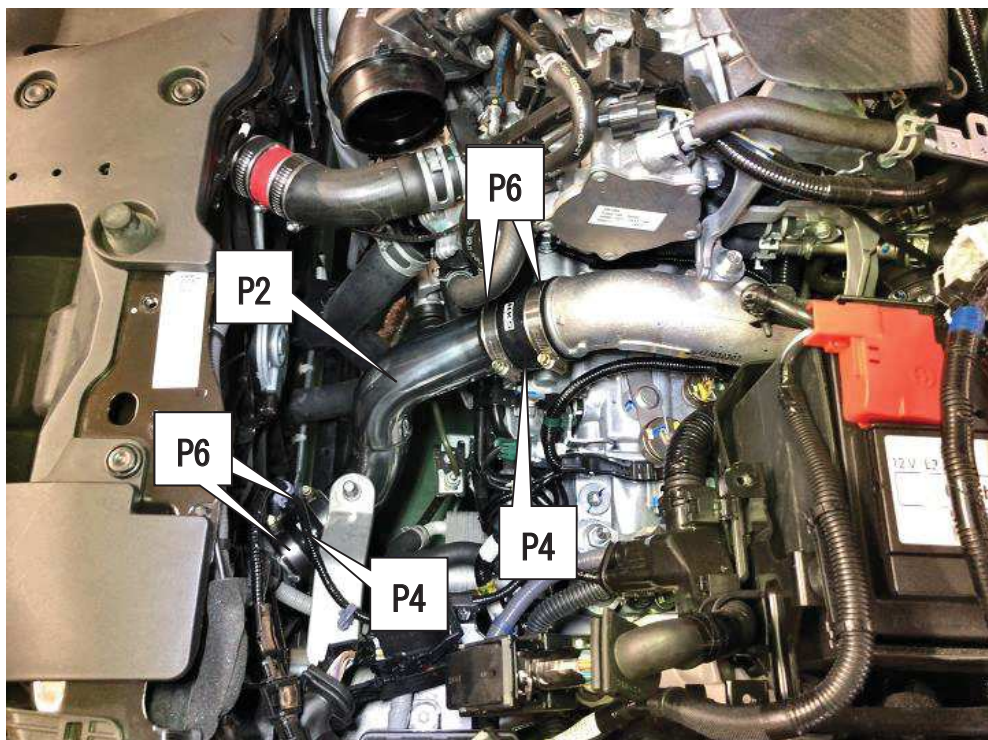

3. REINSTALLATION OF FACTORY PARTS

- (1) Make sure the installed parts do not contact with any other parts of the vehicle.
 - (2) Reconnect the negative cable to the battery.
 - (3) Start the engine; then make sure the installed parts do not contact with any other parts of the vehicle.
 - (4) Reinstall the factory parts ① - ④ removed in 1.
- ※ After the installation process is complete, check all items listed in the “Confirmation after Installation” section of the Instruction Manual.